

# Haier

**HW-ZA101DBT**







User Manual

## CONTENTS

Instruction .....	2
Display&Operation .....	3
Wired Controller Wiring Instruction .....	15



## Button Instruction

 Menu	Menu Button, press this button to enter the Menu function
	Set the fan speed in home page, or switch options in other interface
	Set the setpoint temperature in home page, or switch options in other interface
	Confirm/Shift Button, set Mode in home page, confirm or switch parameters in other interface
	Power On/Off Button
 Back	Return Back Button
 Zone	Zone Control Button

## Display & Operation

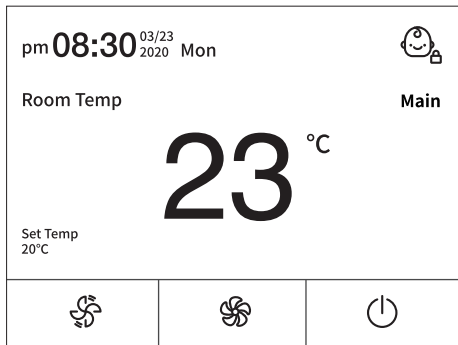

1. Green light indicates the device is powered on, Red light indicates the device is powered off.

2. Set Temp indicates the setpoint temperature which shows at the left side of the main interface, press or to adjust the setting temperature, then press to confirm after the setting is completed. The temperature setpoint range is from 16-30°C(60-86°F), the adjustment range is limited in Energy Saving mode, for more information, please refer to the following Energy Saving mode description.

3. **Child Lock:** Hold and synchronously for 3S in home page to enable the lock and unlock function.

### 4. Mode Setting

Press button to execute mode switch.

Auto	Cooling	Dry	Heating	Ventilation

### 5. Fan Speed Setting

Press button to adjust fan speed.

Low	Medium	High	Auto

### • Zone Management Control

Press to enter zone function.

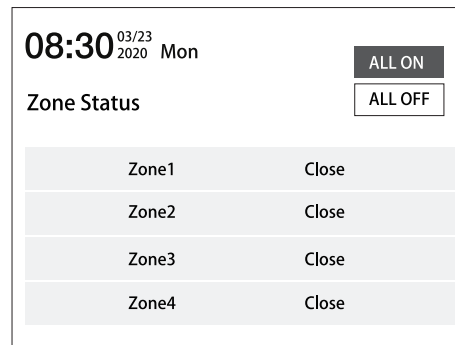

1. In this interface, press ▲ or ▼ to switch the icon, press ○ to change the on/off state of the available damper, after the setting is completed, press ↶ to execute immediately.

2. In this screen, dampers can be opened and closed individually.

3. ALL ON & ALL OFF these icons indicate dampers can be turned on or turned off simultaneously.

4. When the air conditioner is off, all dampers will be open automatically.

## • Menu Function

Press  to enter menu screen.

Use ◀ ▶ to shift and ○ to enter.

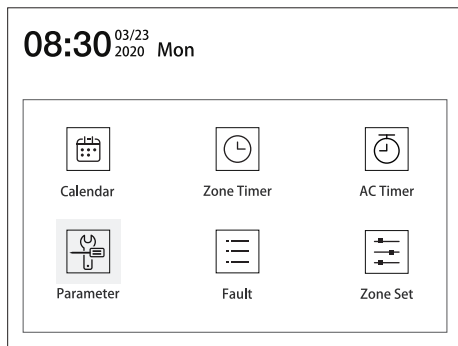

## • Calendar Setting

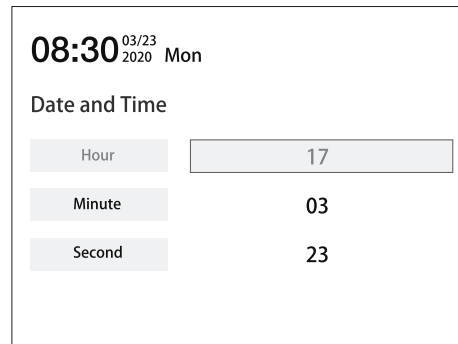
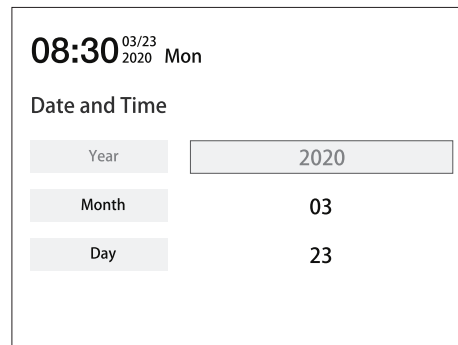

In this screen, press ▲ or ▼ to shift the items, press ◀ or ▶ to adjust the parameter. After the date is set, the week will be automatically displayed.

## • Weekly Schedule

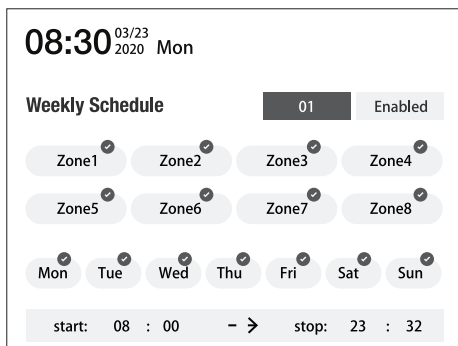

1. Max. 20 timers can be set which is indicated by numbers ranging from 01 to 20. When the cursor is put on the timer program No., press  to confirm, then use the ▲ or ▼ check all the timer programs. Press ◀ or ▶ to exit check when the cursor is put on the No..

2. For each timer program, user can select the related zones and days. For each timer program, the zones and days involved can be set. Press ⬆ or ⬇ to move the cursor and press  to confirm or cancel the selection.

3. For the time adjustment, when the cursor fixed on the time, press  to confirm and use ▲ to ▼ adjust the value. Long press ▲ or ▼ to achieve quick adjustment.

4. The set timer can be set by Enabled/Disabled. When the timer is set to Disabled, this timer function will not be executed.

## • AC Timer

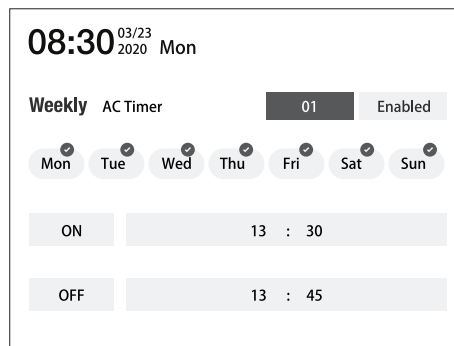

1. Max. 10 timers can be set which is indicated by numbers ranging from 01 to 10. When the cursor is put on the timer program No., press  to confirm, then use the ▲ or ▼ check all the timer programs. Press ◀ or ▶ to exit check when the cursor is put on the No..

2. For each timer program, user can select the related days. For each timer program, when the timer program setting is valid, the days involved can be set. Press ⬆ or ⬇ to move the cursor and press  to confirm or cancel the selection.

3. For the time adjustment, when the cursor fixed on the time, press  to confirm and use ▲ to ▼ adjust the value. Long press ▲ or ▼ to achieve quick adjustment.

4. The set timer can be set by Enabled/Disabled. When the timer is set to Disabled, this timer function will not be executed.

- Zone setting for installers

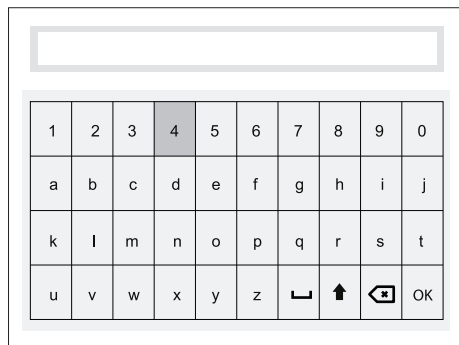
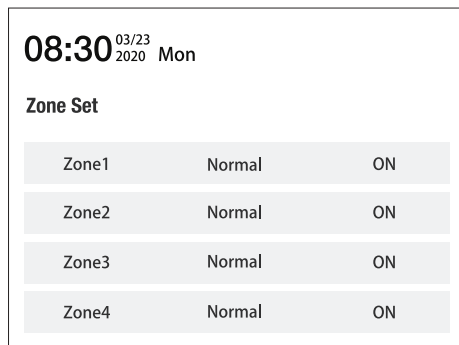

1. This function is only available for installers' operation. The password is 841226. Use ◀ ▶ to shift digits , ▲ ▼ to adjust value and ○ to confirm.

2. The second column indicates the normal zone or the constant zone. Normal zone means it can be normally turned on or turned off. Constant zone means it will be automatically turned on and will be constantly on when other zones are off. When the air conditioner is OFF, all the normally-open damper will be ON automatically.

3. The third column indicates the zones can be turned on or turned off by installers. If the zone is set off which means it will not appear to the user.

4. The first column indicates the zone name, which is allowable for rename. Select the zone to be renamed, press the ○ to enter into the keypad window. Press ▲ ▼ to select and OK to confirm. The zone name length is 6 digits.

- Parameter Setting

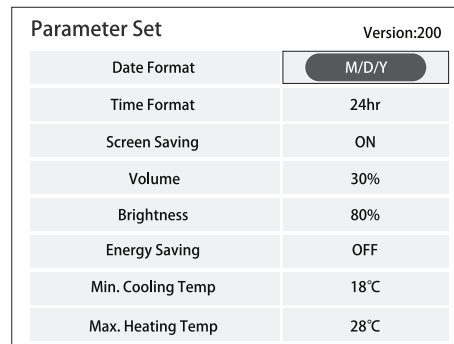

Parameter Set		Version:295
ESP Grade	02	
Room Temp. Collection	Controller	
F/C	F	
Cool Temp. Compensation	00	
Heat Temp. Compensation	00	
Main/Sub	Main	
Filter Reset	OFF	
Factory Reset	OFF	

Parameter Set		Version:295
Temp. compensation	00°C	
Zone. Hd Reverse	OFF	

#### 1. Date Format

Date display format: there are three formats can be set ①M/D/Y ②

Y/M/D ③D/M/Y

2. **Time Format** Time display format: 12-hour and 24-hour system.

3. **Screen Saving** Screen saving time: ①15s ②30s ③1min ④3min ⑤the screen brightness is always on. Without any operation, the screen brightness turns off according to the set time.

4. **Volume** Beep or buzzer: ①30% ②60% ③100% ④Off

5. **Brightness** Backlight brightness setting: ①30% ②50% ③60% ④80% ⑤100%

#### 6. Energy saving mode:

① Only after this function is set on, the setting of the minimum energy-saving temperature in Cooling/Dry mode and the maximum energy-saving temperature in Heating mode is valid. The parameter setting range is 16-30°C. The minimum energy saving temperature is 23°C (74°F) as initial default setting in Cooling/Dry mode, and the maximum energy saving temperature is 26°C (78°F) as initial default setting in Heating mode.

② After this function is activated, the setpoint temperature setting range is limited to 23-30°C in Cooling/Dry mode, in Heating mode it is limited to 16-26°C

③ The energy saving function is initially off. by default.

7. **ESP Grade** Static pressure setting: It can be adjusted based on actual static pressure grades of indoor unit.

8. **Room Temp.Collection** The room temperature data source can be selected from: ① Controller ② Interface ③ IDU

9. **F/C** Fahrenheit/Celsius temperature format switch: after the format is set, all temperature parameters will be followed to the set format.

10. **Cool Temp. Compensation** **Heat Temp. Compensation** Cooling/Heating temperature compensation for indoor unit, this function is mainly operated by installer to set the indoor temperature compensation for indoor unit. Some indoor unit doesn't support this function, the icon displays grey indicating that it is not adjustable.

11. **Main/Sub** Main/Sub controller setting: when it is set to slave, some functions cannot be set.

12. **Filter Reset** Filter Reset: when the controller display filter icon, indicating that it can be reset and cleared.

13. **Factory Reset** Factory Reset: when the factory reset is set into on, all the settings will reset to the factory defaults

14. **Temp.compensation** (1) When it is Celsius, the range of parameter adjustment is -4 ~ 4. When it is Fahrenheit, the range of parameter adjustment is -8 ~ 8.  
(2) This function is valid only during collecting ambient temperature of wired controller.

15. **Zone.Hd Reverse**  
Change the operating status of the air valve.

## • Error Code

NO	YEAR, MONTH, DAY	HOUR:MINUTE	TYPE
01:	.....	.....	.....
02:	.....	.....	.....
03:	.....	.....	.....
04:	.....	.....	.....
05:	.....	.....	.....
06:	.....	.....	.....
07:	.....	.....	.....
08:	.....	.....	.....
Current Fault			1

Note: The enter key will delete all records

In this interface, the current faults and historical faults can be checked. Press  to delete all historical faults.

## • Interface

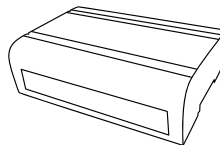

There are 8 indicator lights on the interface which indicates 8 dampers. When the damper opened, the red indicator light turns on. When the air valve closed, the red indicator light turns off.



## Wired Controller Wiring Instruction

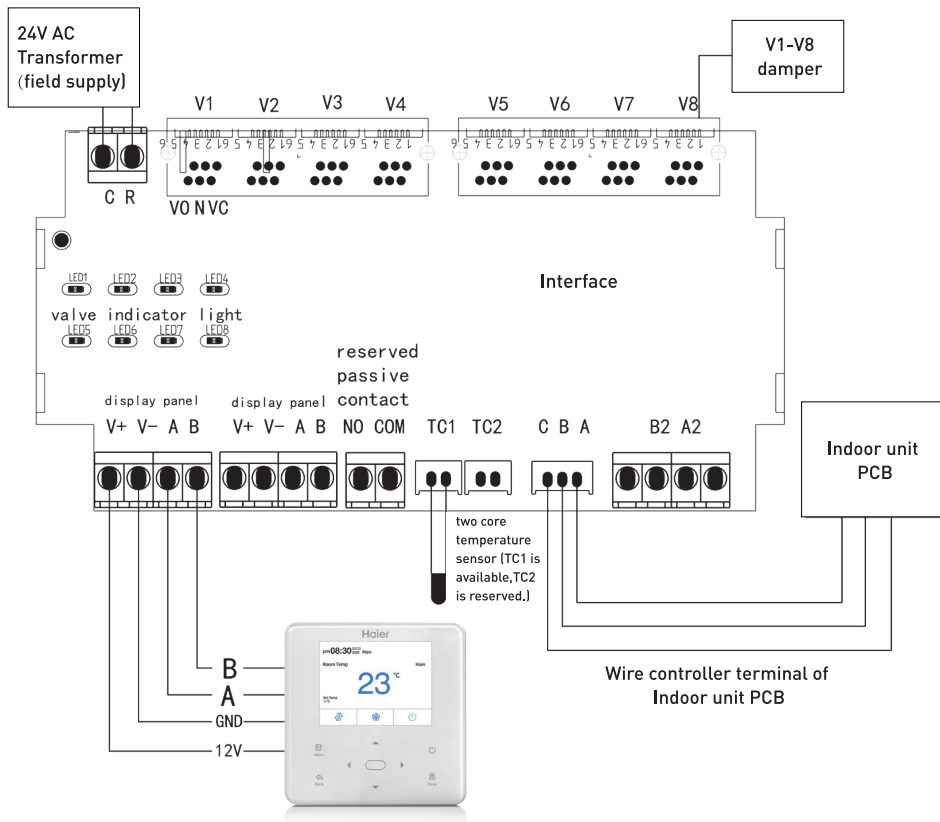

• Note

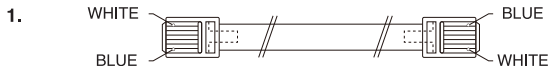

1. The wire connecting damper and control interface should be field supplied. Be sure the wire sequences are the same otherwise the damper will not be controlled normally.

2. The power consumption of 24V AC power adapter should not be less than the total power consumption of the whole zone system. The total power consumption includes the power consumption of total dampers involved ( VA per damper times installed zones qty.) and the control box (approximately 5w). For example, the power consumption per damper is 5w and the zones installed are 8. In this case, to ensure the zone system works normally, the 24V AC power adapter should not be less than 45VA .

3. The indoor unit PCB connector to zone controller is same as the connector to wired controllers, please check the indoor unit wiring diagram

4.

Communication Wiring Length	Dimension of Wiring
0~100 ft (0~30m)	22AWG(0.3mm <sup>2</sup> )x3-core shielded wire
100~200 ft (30~60m)	20AWG(0.5mm <sup>2</sup> )x3-core shielded wire
200~300 ft (0~90m)	18AWG(0.75mm <sup>2</sup> )x3-core shielded wire

• Installation instruction:

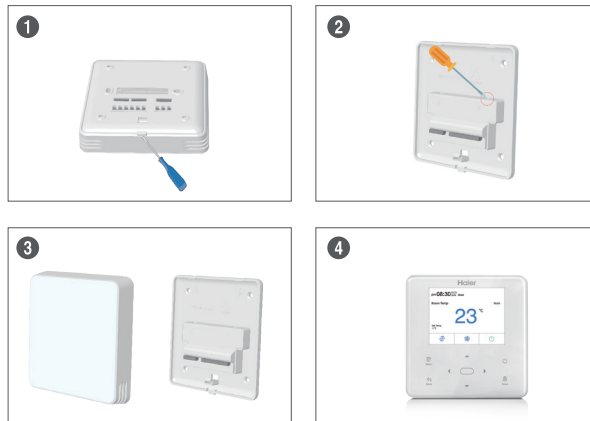

1. Use a screwdriver to take apart the controller bottom shell.

2. Use a screwdriver to take apart the cover plate of the connection terminal for wiring connection. After the wiring connection is completed, install the bottom shell of the controller on the wall.

3. Connect the wired product to its upper buckle along the arrow direction of the bottom shell of the controller, and then press the lower part evenly.

4. Check the whole device is installed correctly, then power it on and operate according to the user manual.